

16.1 General

It is used for the periodic check of accumulator pre-charge and for the inflation of accumulators themselves after the replacement of the bladder or it is used for the change of pre-charge value. For the inflation is necessary a connection to a bottle filled with industrial dry nitrogen with a pressure higher than the precharge value required, provided with **pressure reducer** (mandatory, for safety reasons, during the inflation of accumulators with PS < 210 bar).

Furthermore the use of a pressure reducer make easier the **slow and graduated** inflow of nitrogen on the bladder avoiding in this way the possibility of damaging of the bladder itself.

16.2 Construction

STANDARD VERSION includes:

- Valve body complete with ring nut connection to accumulator gas valve, pressure gauge, bleed and non return snap-in hose connection.
- 3 m charging hose for high pressure series complete with bottle connections.
- One connection nipple to pressure reducer.
- Set of spare gaskets.
- Case.

ON REQUEST:

- ADAPTER for special accumulator gas valves.
- CHARGING HOSE with length of 6 m.



16.3 Technical features

Max working pressure: 600 bar

Accumul. connection: 5/8" UNF (standard)
7/8" UNF; \varnothing 7,7x1/32" (Vg8); 1/4" ISO 228; (on request)

Bottle connection: See designation (ch 16.5), drawings and table ch. 16.7 page 35

Pressure gauges: - \varnothing 63 connection 1/4" ISO 228
- Full scale 250 bar for high pressure accumulators
- Full scale 25 bar for low pressure accumulators

Weight: 1,8 kg (case included)

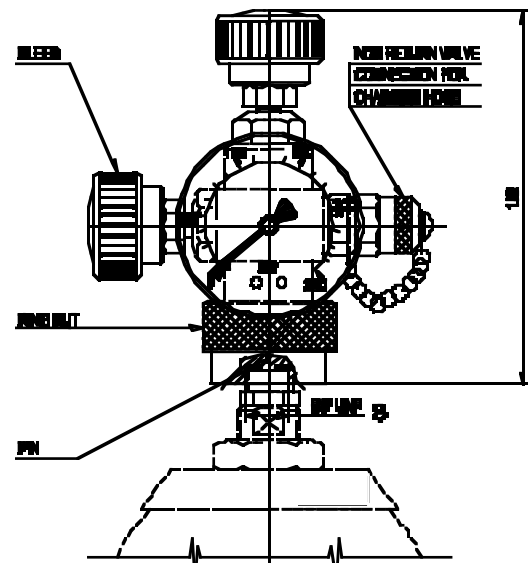

16.4 Spare parts

Gasket set	2160	Complete bleed	2164
Non-return valve	2162	Charging hose	2166/(metres)
Central pin	2165	Pressure gauge	2163/(bar)

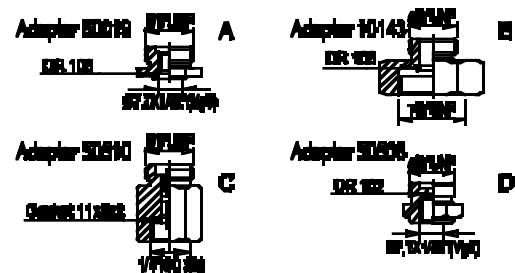

16.5 Identification code

The example below shows equipment for filling and checking with pressure gauge of 250 bar, with accumulator connection 5/8" UNF and standard bottle connection, complete with 3 m hose and case.

SAMPLE OF DESIGNATION:

PC		250		S		1		-		-				
Type	Pressure gauge (bar)	Connection to accumulator		Connection to bottle ¹⁾ (according to Country standards)				Charging hose (metres)						
PC Pre-loading and checking	25	S = 5/8" UNF (standard)		1 = Italy 2 = Austria Czech Republic Denmark Finland Germany Netherlands Norway Poland Sweden Switzerland	3 = Belgium Egypt France Hungary Mexico Morocco Romania Saudi Arabia Slovenia Spain Tunisia	4 = Argentina Australia Great Britain Greece India Indonesia New Zealand Philippines Portugal Singapore Turkey	5 = Brazil South America	6 = South Africa	7 = Canada USA	8 = Russia Venezuela	9 = Japan	10 = Taiwan	11 = China	12 = Korea
	250	A = \varnothing 7,7x1/32" (Vg8) (adapter 50019) B = 7/8" UNF (adapter 10143) C = 1/4" ISO 228 (adapter 50510) D = \varnothing 7,7x1/32" (Vg8) (long thread) (adapter 50508)												
								- = 3 m (standard) L = 6 m (on request)						

1) Other types on request

16.6 Connection charging hose - pressure reducer



The use of pre-loading set for the inflation of accumulators "low pressure" series requires, for safety reasons, the use of a **pressure reducer mounted on the nitrogen bottle** calibrated at a pressure equal or lower than the max working pressure PS marked on the accumulator body. The connection nipple between charging hose and reducer it is showed by the side of the page and it is normally supplied with the pre-loading set.

Nipple No. 11447

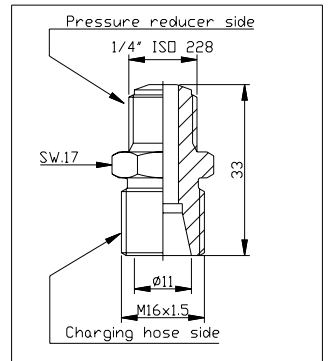

16.7 Connection charging hose - additional bottle

For "high pressure" accumulators and, in general, for all the types with PS ≥210 bar, it is possible to connect the nitrogen bottle through the proper nipple without the use of pressure reducer. The proper nipple has to be chosen according to the origin Country of nitrogen bottle, as showed on the table below. The number of the column indicated with x stands for the fig. of the nipple valid for such Country and coincide with the number used for the indication of bottle connection in the designation code (ch. 16.5). Each nipple has an own code (indicated on) to be used for spare parts order and not on the designation of the pre-loading set.



Fig. 1 (No.2167)

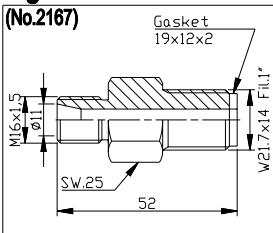

Fig. 2 (No.2168)

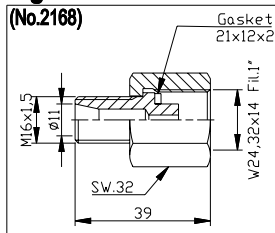

Fig. 3 (No.2169)

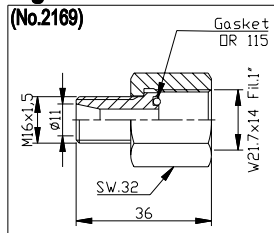

Fig. 4 (No.2171)

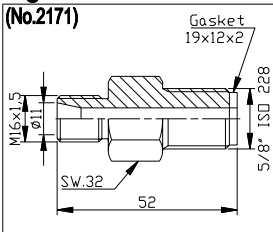

Fig. 5 (No.2173)

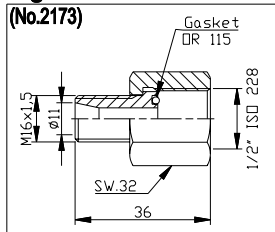

Fig. 6 (No.2294)

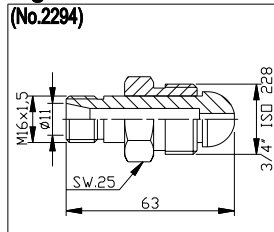

Fig. 7 (No.2172)

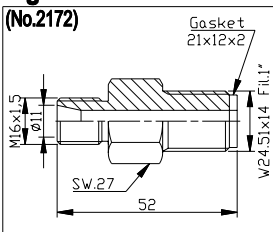

Fig. 8 (No.2254)

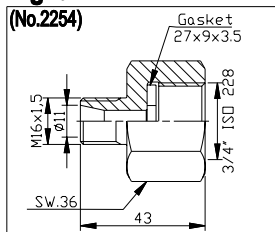

Fig. 9 (No.2170)

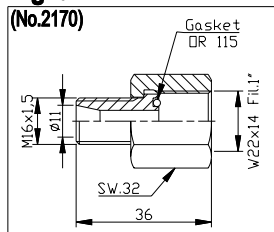

Fig. 10 (No.2174)

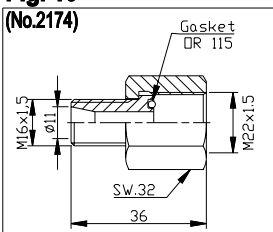

Fig. 11 (No.2266)

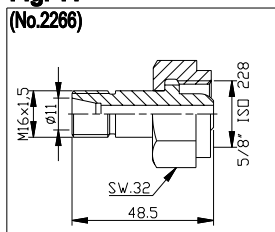
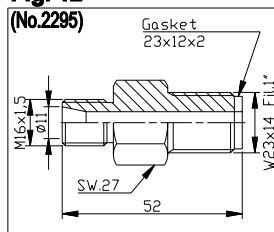

Fig. 12 (No.2295)



COUNTRY	Fig. No.											
	1	2	3	4	5	6	7	8	9	10	11	12
Argentina				X								
Australia				X								
Austria	X											
Belgium	X											
Brazil					X							
Canada						X						
China											X	
Czech Republic	X											
Denmark	X											
Egypt				X								
Finland	X											
France				X								
Germany	X											
Great Britain					X							
Greece					X							
Hungary				X								
India					X							
Indonesia					X							
Italy	X											
Japan									X			
Korea												X
Mexico			X									
Morocco			X									
Netherlands	X											
New Zealand				X								
Norway	X											
Philippines				X								
Poland	X											
Portugal				X								
Romania			X									
Russia								X				
Saudi Arabia			X									
Singapore				X								
Slovenia			X									
South Africa						X						
South America					X							
Spain			X									
Sweden	X											
Switzerland	X											
Taiwan											X	
Tunisia			X									
Turkey				X								
USA								X				
Venezuela								X				